

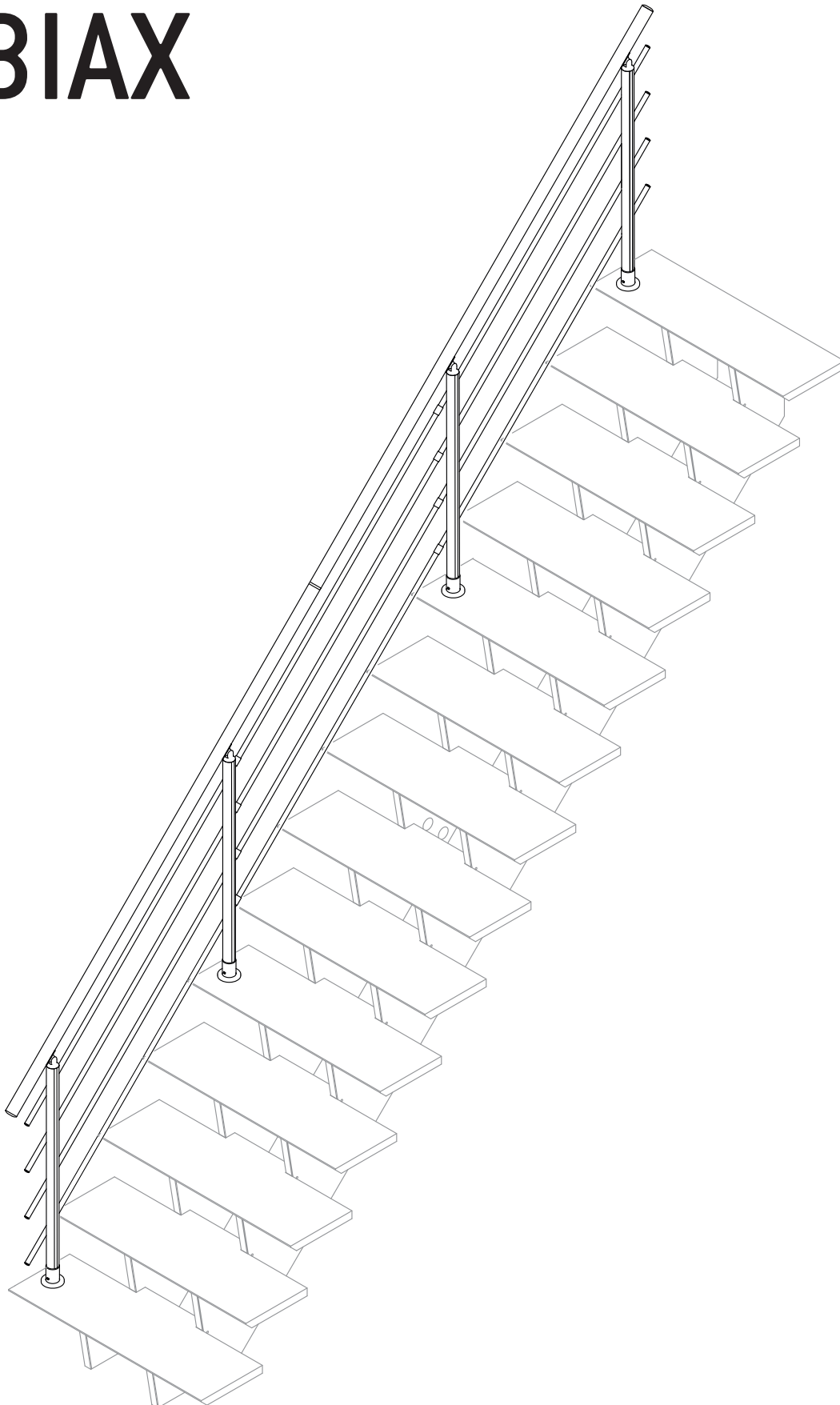

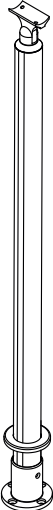







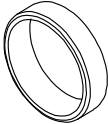
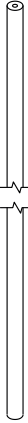
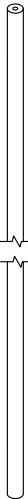



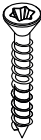
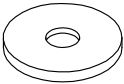

BIAX



<p>19 040x840 x4</p> 	<p>20 040x2013 x2</p> 	<p>21 012x60 x2</p> 	<p>22 016x1230 x4</p> 	<p>23 016x1385 x8</p> 	<p>24 012x60 x1</p> 
					<p>25 05,8x60 x8</p> 
<p>26 M12x70 x4</p> 	<p>27 024x3 x4</p> 	<p>28 M12x19x22 x4</p> 	<p>29 04x30 x16+2</p> 	<p>30 036x4 x1</p> 	<p>31 020x40 x8</p> 
<p>32 016x12 x8</p> 	<p>33 04,2x45 x16+1</p> 	<p>34 04,2x13 x8</p> 	<p>35 40x99x23 x1</p> 	<p>36 04x25 x8</p> 	 

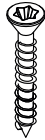

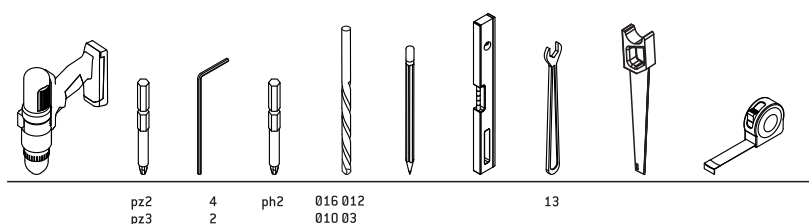
1

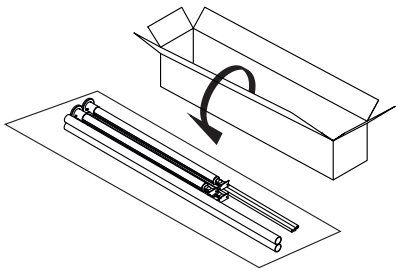

2

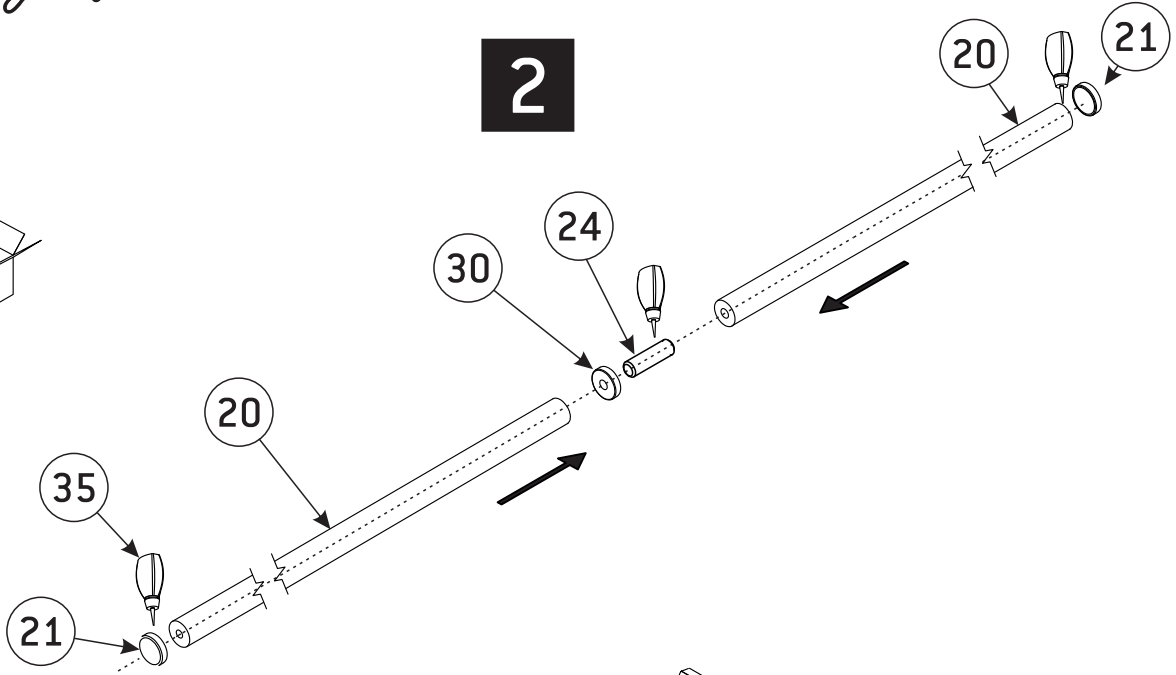

3

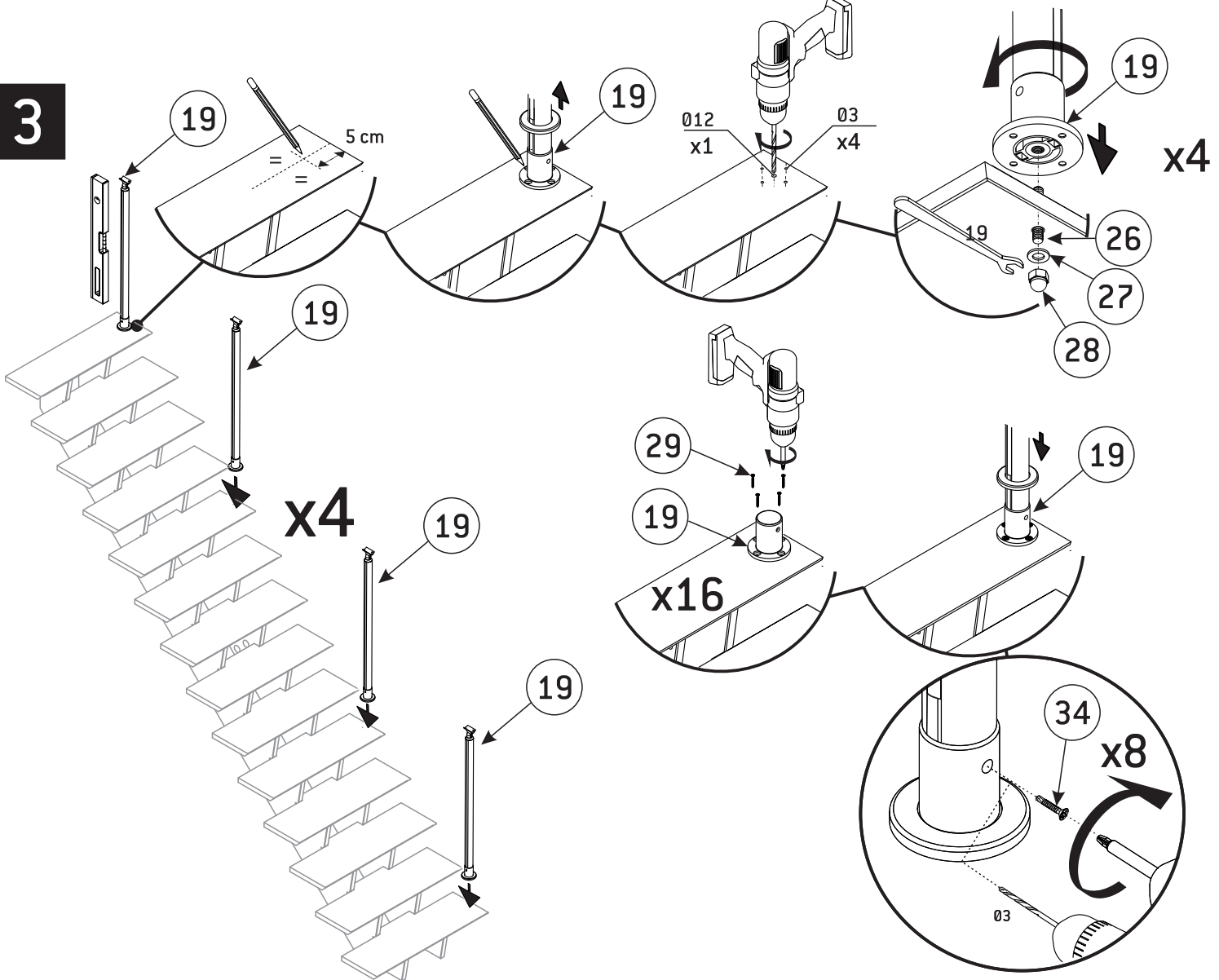

4

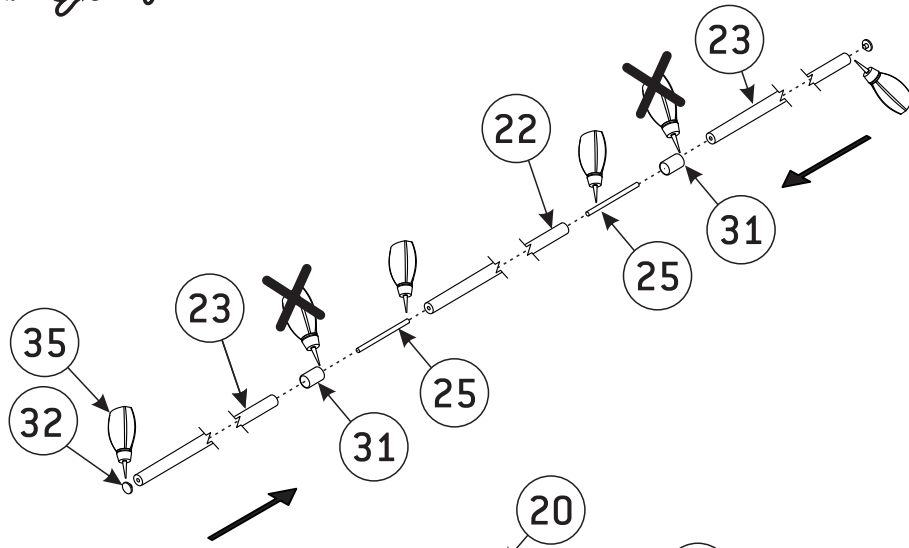

5

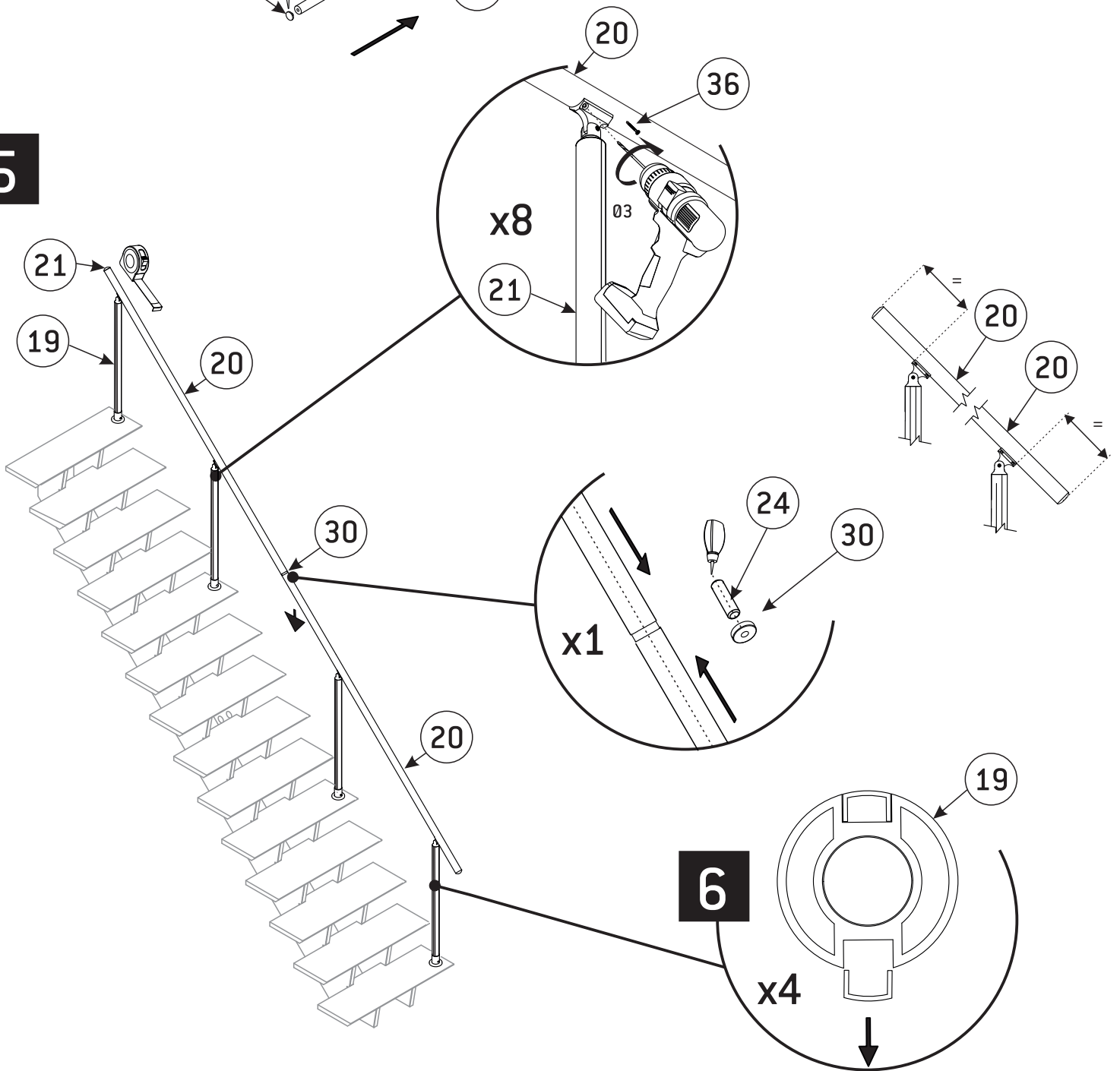

6

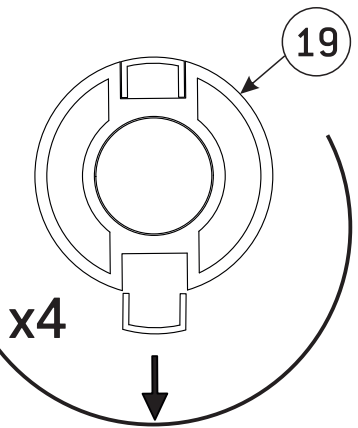

7

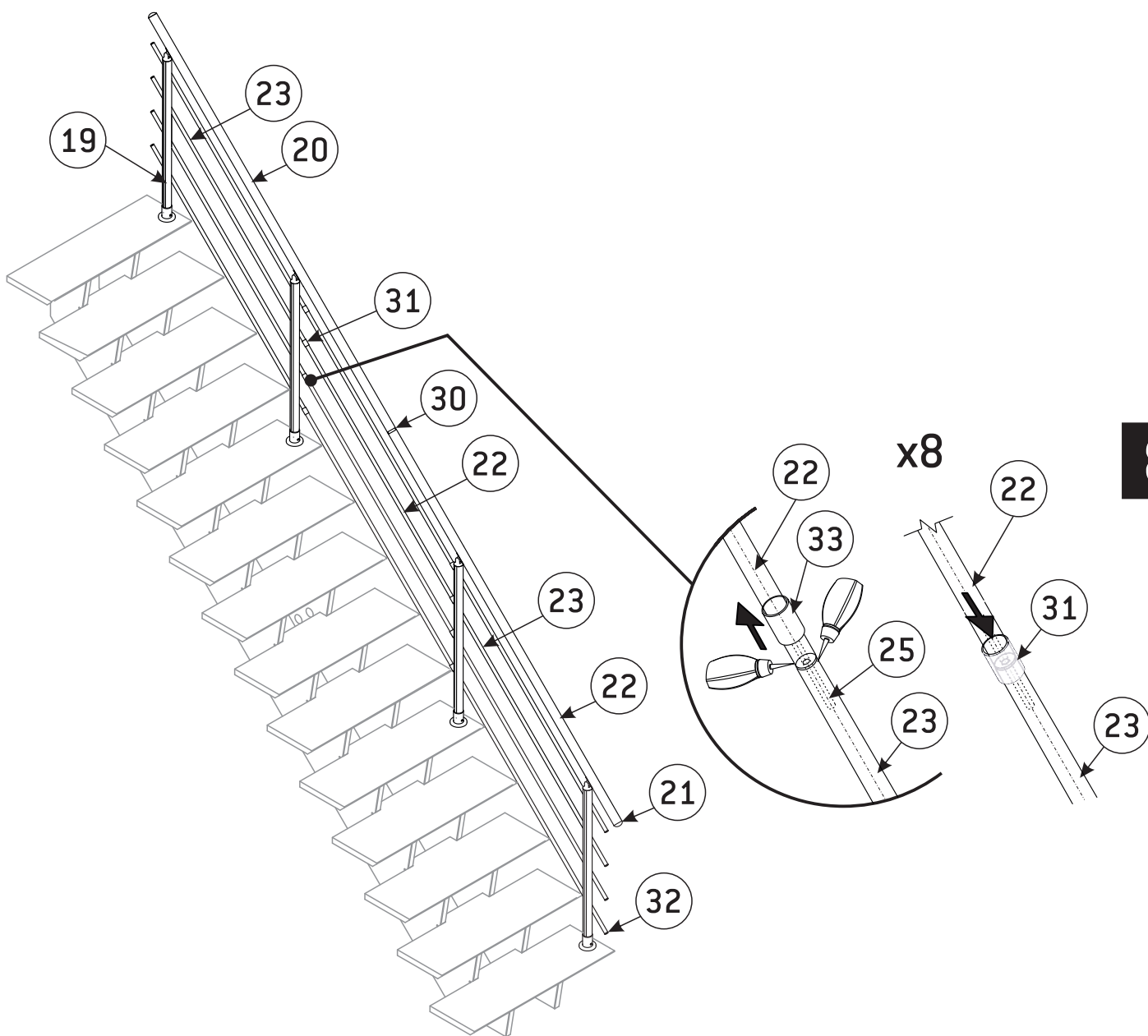
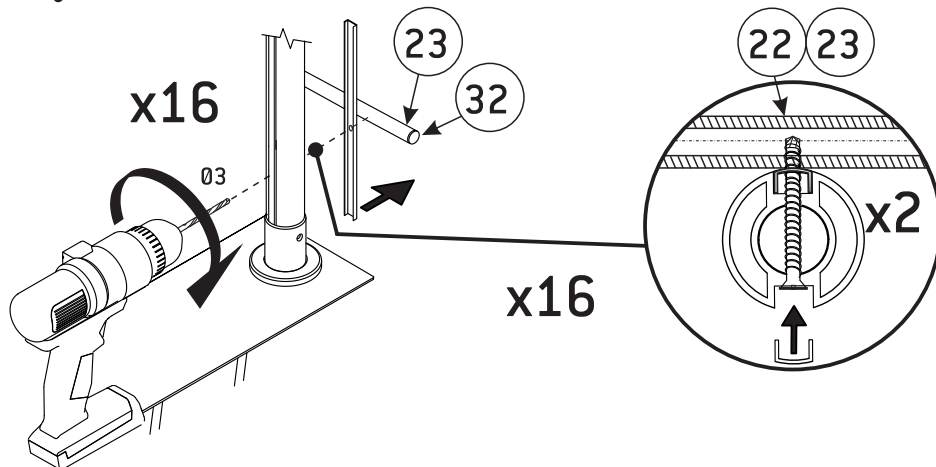

8